



**PML**<sup>®</sup> Arredamenti Ufficio  
**Sedute Contract e Attesa**  
*- Pozzetti e Divani*





**PM** Glamour

Poltrona pozzetto  
con ruote o piedini  
Armchair  
with castors or feet

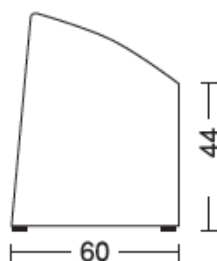

Glamour 01

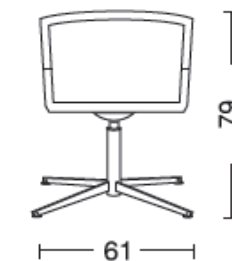

Glamour 05



## ANSA

Poltrona d'attesa e per sale riunione, la collezione Ansa si contraddistingue per la ricercatezza formale del design.



**PM**® Ansa

Poltrona pozzetto con ruote  
Armchair with castors

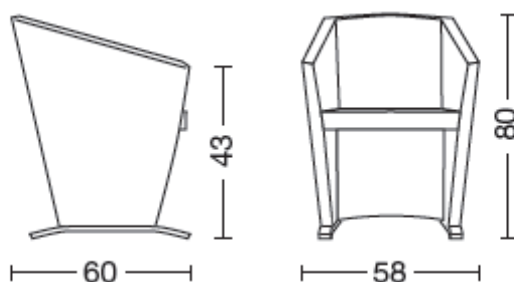

# Diana

Diana è una poltrona dalle linee morbide ed avvolgenti. Ideata per arredare piccoli spazi di attesa e reception.



**DIANA 01**



**DIANA 02**



## Diana 01

Poltrona pozzetto, struttura interna in acciaio e resine poliuretaniche con piedini

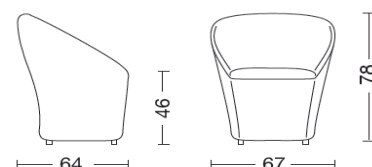

## Diana 02

Poltrona girevole, struttura interna in acciaio e resine poliuretaniche, base girevole autoallineante

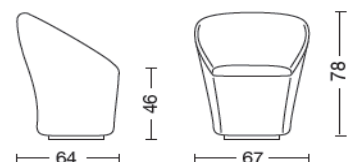

# Egg

Egg è una sedia che può trovare collocazione accanto ad altri arredi, sia nell'ambiente ufficio sia contract o collettivo. La seduta girevole è su varie tipologie di basamento.



**EGG 01**



**EGG 02**



## Egg 01

Poltrona girevole, struttura interna in acciaio e resine poliuretaniche, base in acciaio cromato 4 razze piatte

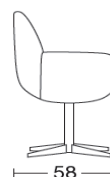

58

46



59

87



## Egg 02

Poltrona girevole, struttura interna in acciaio e resine poliuretaniche, base in acciaio inox cromata



58

46



59

87

# Spoon

Seduta ideale per il settore contract, monoscocca in schiumato a freddo, con possibilità di varie tipologie di base. A seconda dei desideri rivestibile in tessuto, ecopelle o pelle.



**SPOON 01**



**SPOON 02**

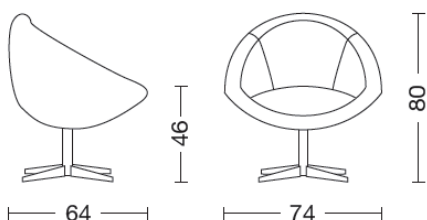

**Spoon 01**

Poltrona girevole, struttura interna in acciaio e resine poliuretaniche, base in acciaio cromato 4 razze piatte

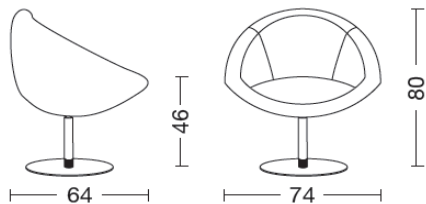

**Spoon 02**

Poltrona girevole, struttura interna in acciaio e resine poliuretaniche, base in acciaio inox cromata

# Enea

Con il suo design classico, la sua versatilità totale e il suo comfort, la poltrona Enea è indispensabile nell'utilizzo contract.

*With its classic design, its total versatility and its comfort Enea armchair can't miss in a contract use.*



## Enea 01

Poltrona girevole, struttura interna in acciaio e resine poliuretaniche, base in acciaio cromato 4 razze piatte

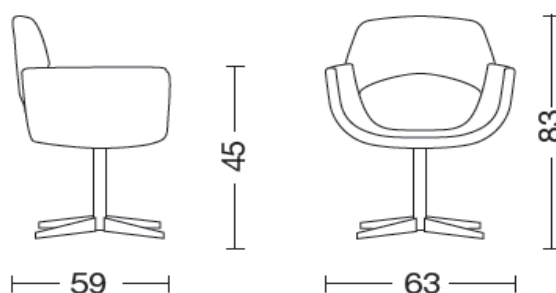

# Cube

Poltroncina multiuso per ufficio, zona attesa, e visitatore. Struttura imbottita con poliuretano schiumato a freddo e rivestita con tessuto / ecopelle o pelle. Molti colori disponibili.

*Multipurpose armchair for office, waiting rooms, meeting rooms and visitor. Structure is padded with cold-foamed polyurethane and upholstered with fabric, ecoleather or leather at your choice. Many colors available.*



Cube

Poltrona pozzetto, struttura interna in acciaio e resine poliuretaniche, con piedini o ruote  
Armchair, internal structure in steel and polyurethane foams, with feet or castors

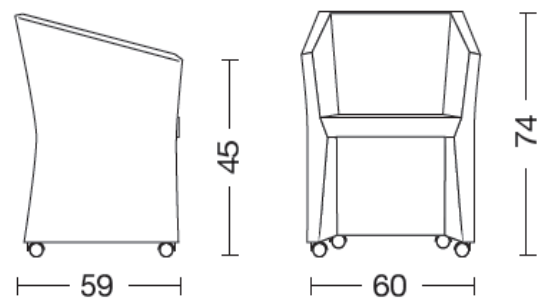

# Ausilia

Poltroncina adatta per il contract e residenziale.  
Struttura in poliuretano schiumato a freddo  
e gambe in legno di faggio verniciato.  
Sedile e schienale imbottiti. Disponibile in molteplici  
varianti in tessuto e pelle.

*Little armchair suitable  
for contract and residential.  
Structure made by cold foamed  
polyurethane and painted wood  
beech legs. Padded seat  
and backrest. Available with  
several fabrics/leathers colors.*

44



Ausilia

Poltrona 4 gambe in legno o rivestite, struttura interna in acciaio e resine poliuretatiche  
Armchair 4 wooden or upholstered legs, internal structure in steel and polyurethane foams

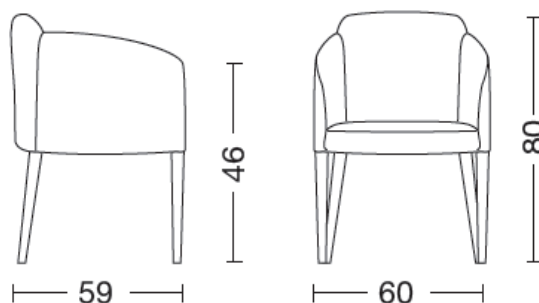

# Lexus

Poltrona ideale per zona attesa e visitatore. Linee dinamiche per una poltrona ergonomicamente accogliente ed avvolgente. Disponibile in molteplici varianti in tessuto e pelle.

*Ideal armchair for waiting areas and visitor. Dynamic lines for a welcoming and wrapping armchair. Offered with several textiles and leather colors.*

40



LEXUS 01



## Lexus 01

Poltrona girevole,  
struttura interna in acciaio e resine poliuretaniche,  
base in acciaio inox cromata

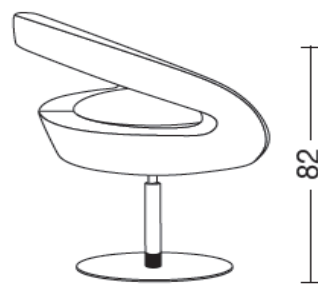



Ice 01



Ice 02



Ice 03



Ice 04



### Ice 01

Poltrona girevole, scocca in legno  
base in acciaio cromato 4 razze piatte  
Swivel armchair, wood frame,  
4 flat stars chromed steel base

#### Colore legno:

Colore legno:  
wengé, bianco, ciliegio

#### Wood colours:

wengé, white, cherry



### Ice 02

Poltrona girevole, scocca in legno  
base in acciaio inox cromata  
Swivel armchair, wood frame,  
chromed stainless steel base

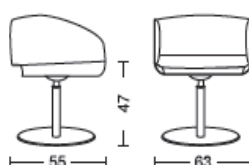

### Ice 03

Poltrona girevole, scocca in legno  
base in acciaio cromato 4 razze mod. piramidale  
Swivel armchair, wood frame,  
4 pyramid-shaped stars chromed steel base

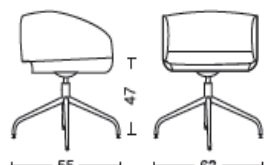

### Ice 04

Poltrona girevole, scocca in legno  
base in alluminio pressa fuso lucido mod. PC1  
ruote gommate  
Swivel armchair, wood frame,  
PC1 model base in die-cast polished aluminium  
gum castors

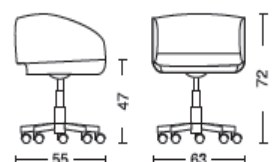

# Puppis



Puppis 01



Puppis 03



Puppis 04



## Puppis 01

Poltrona girevole, struttura interna in acciaio e resine poliuretaniche



## Puppis 03

Poltrona girevole, struttura interna in acciaio e resine poliuretaniche base in acciaio cromato 4 razze mod. piramidale

## Puppis 04

Poltrona girevole, struttura interna in acciaio e resine poliuretaniche base in acciaio inox cromata

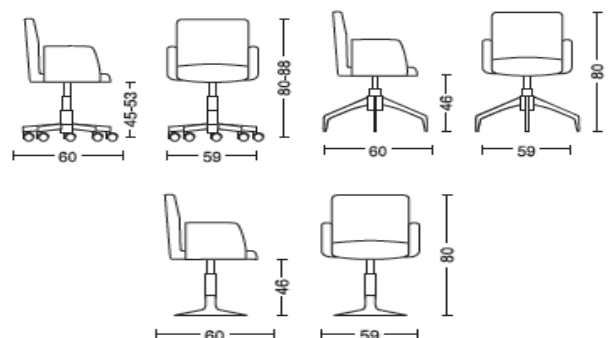

# Betty

Le linee pulite e design raffinato si adattano ad ogni area dove una seduta di attesa professionale ed accogliente sia necessaria.



## Betty - Divano / Sofa

Divano a 2 posti con struttura in acciaio  
imbottitura in poliuretano ignifugo schiumato a freddo  
2-seats sofa with steel supporting frame,  
padding in cold-foamed fire-retardant polyurethane

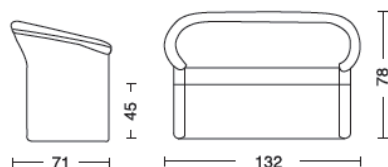

## Betty - Poltrona / Armchair

Poltrona con struttura in acciaio,  
imbottitura in poliuretano ignifugo schiumato a freddo  
Armchair with steel supporting frame,  
padding in cold-foamed fire-retardant polyurethane

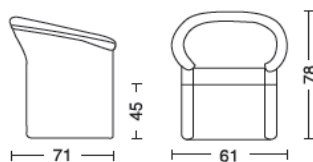

# t i d e

## s i s t e m a   p o l t r o n e   c o m p o n i b i l i

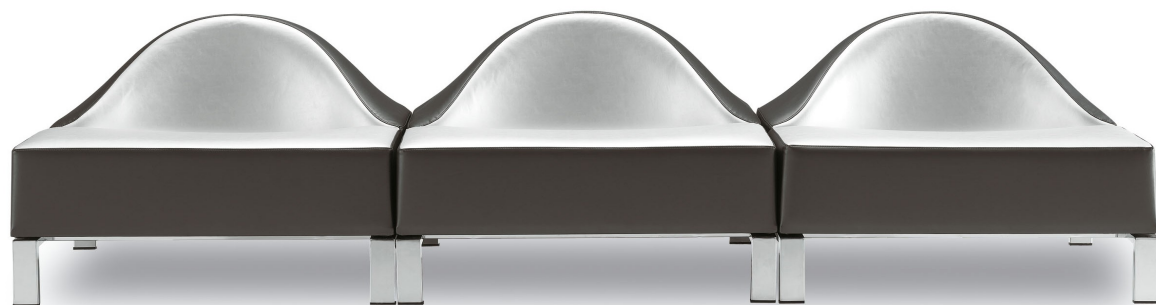

Il sistema si compone elementi modulari aggregati, sedute con schienale e pouf, che consentono accostamenti senza limiti e permettono di formare divani lineari, angolari e a penisola. Componibilità ed articolazione in numerose tipologie, una nuova risposta che sapientemente coniuga comfort e raffinatezza formale.



tide high  
L76xP76xH75



tide low  
L76xP76xH42



tide table  
L76xP76xH26



### Tide High 03

Poltrona attesa con schienale  
struttura telaio cromato  
Reception armchair with backrest  
chromed frame structure



### Tide Low 04

Poltrona pouf,  
struttura telaio cromato  
Pouf armchair,  
chromed frame structure

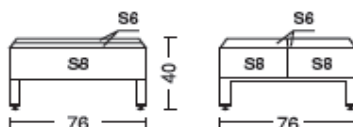
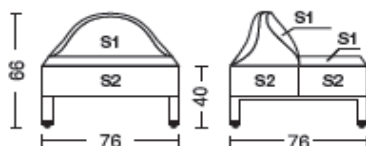

### Tide Table 05

Tavolino con telaio cromato,  
in legno o nella versione laccato opaco liscio  
Chromed frame table,  
in wood or lacquered version

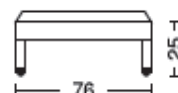

# Dado



Dado 10

Dado 11

Dado 12

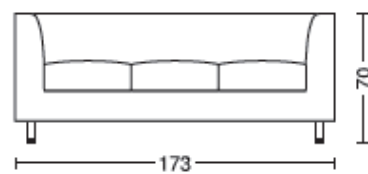
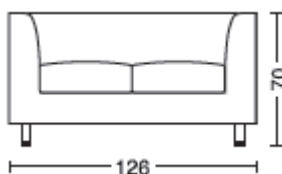
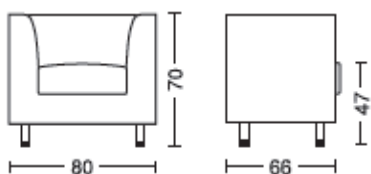



50

**KAMI 01**

# Kami

Design  
Marc Sadler

Poltrona monoscocca adatta sia per gli spazi domestici, sia per attesa e ambienti collettivi (uffici, alberghi). È realizzata in polietilene opaco o lucido.

*Monocoque armchair suitable for home spaces, for waiting areas and for public surroundings like i.e. offices, hotel etc...  
Realized and available on polyethylene, dull or polished version.*



Design  
Marc Sadler



**KAMI SAN**



**Kami 01** DESIGN BY MARC SADLER

Poltrona monoscocca senza braccioli, in polietilene opaco o lucido.

**Kami 02** DESIGN BY MARC SADLER

Poltrona monoscocca con braccioli, in polietilene opaco o lucido.

**Kami san 01** DESIGN BY MARC SADLER

Divano con braccioli, in polietilene opaco o lucido.

**Kami tav** DESIGN BY MARC SADLER

Tavolino in polietilene opaco o lucido, cristallo incluso.



**KAMI**



# Rap

Design  
Karim Rashid



Nuova seduta dal design essenziale e lineare: Rap sintetizza al meglio la tradizionale idea di divano con la modernità del polietilene lavorato con la tecnica dello stampo rotazionale. È una poltroncina che mescola perfettamente luce e colore ed è disponibile anche in un'inedita versione illuminabile.



**RAP** Karim Rashid

Rap sintetizza al meglio la tradizionale idea di divano con la modernità. Rap rinnova la collaborazione con le grandi firme del design internazionale, grazie a cui luce e colore raggiungono la loro massima espressione. Alla versione illuminabile, disponibile nella colorazione del bianco, si aggiungono numerose varianti cromatiche che spaziano dal verde al rosso, dall'arancio al lavanda.

Prodotto in polietilene stampato in rotazionale.

FORNITURE COLOURS



LACQUERED COLOURS

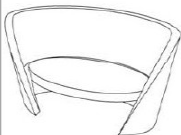
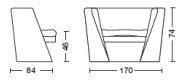

**Rap**  
Karim Rashid

	Code	Dimension ( cm )	Weight ( Kg )
	SD RAP075		50
	Divano 2 posti in polietilene opaco o lucido. Disponibile in vari colori		
Energy saving bulb : 2 x E27 - 25 W			